

Overview

SunWize PV Kits include a solar module, a junction box-mounted charge controller, and a pre-wired output cable. The 20W – 65W kits are offered with an adjustable optional Uni-mount Side of Pole Mount. The 80W – 150W kits are offered with an optional, adjustable, double-rail Side of Pole Mount.

The included SunWize single crystalline, high-efficiency solar modules are manufactured to exceed industry standards providing exceptional reliability and maximum power output. A 20-year warranty reflects the superior quality and assures long product life. All Modules include a 15 ft. (#14 AWG) tray cable.

The waterproof charge controller features a multi-function LED indicator and fuse protection.

The optional aluminum Side of Pole Mounts are designed to fit 2" - 4" diameter SCH40 poles for the Uni-Mounts and 2" - 6" diameter SCH40 poles for the double-rail. Standard banding is provided to fit this range.

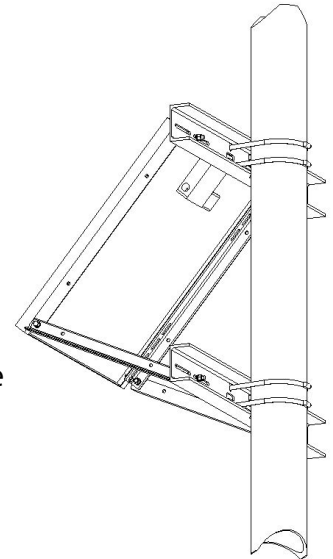

SWPB Part #	Description	Items Included
270022	PVK 20W with Side of Pole Mount	20W module, charge controller, and tray cable
270023	PVK 20W without Mount	
270076	PVK 30W with Side of Pole Mount	30W module, charge controller, and tray cable
270014	PVK 50W with Side of Pole Mount	50W module, charge controller and tray cable
270015	PVK 50W without Mount	
270016	PVK 65W with Side of Pole Mount	65W module, charge controller and tray cable
270017	PVK 65W without Mount	
270018	PVK 80W with Side of Pole Mount	80W module, charge controller and tray cable
270019	PVK 80W without Mount	
270020	PVK 110W with Side of Pole Mount	110W module, charge controller and tray cable
270021	PVK 110W without Mount	
270192	PVK 150W with Side of Pole Mount	150W module, charge controller, and tray cable
270059	PVK 150W without Mount	



20W to 150W module



Morningstar SunKeeper 6A or 12A Charge Controller



Side-of-Pole Mount (optional)

SHOP NOW



Headquarters
30893 Ehlen Drive SW
Albany, OR 97321
(866) 827-6527

