



**PVX-1290T SOLAR BATTERY**

Sun Xtender pioneered renewable energy storage batteries for Off Grid and Grid Tied Solar and Wind Systems as well as uninterruptible power for essential appliances and machines. PVX-1290T is a deep cycle AGM battery.

Since 1987, Sun Xtender has been designing valve regulated lead acid batteries with AGM construction (VRLA-AGM). The non-spillable construction allows the battery to be used upright or on its end or side and the maintenance free AGM design means no water replenishment ever.

Utilizing pure lead calcium grids, the plates are thicker than the industry standard for longer cycle life, increased reliability and power. The low impedance AGM design allows for excellent charge acceptance and there is no current limit required with controlled voltage charging.

The complete Sun Xtender product line features proprietary PolyGuard® Microporous Polyethylene Separators, shielding the positive plates against shorting, shock or vibration. No other manufacturers offer this dual layer insulation protection feature.

Sun Xtender battery covers and containers are uniquely molded with high impact, reinforced copolymer polypropylene and are designed with thick end walls to prevent bulging. The copper alloy T Terminals are corrosion resistant and are supplied with silicon bronze bolts and washers.

All SunXtender Batteries ship Hazmat Exempt.

**PVX-1290T Specifications**

Voltage	12 Volts
Industry Reference	Group 31
Maximum Weight	75 LB / 34.0 KG

**Nominal Capacity Ampere Hours @ 25° C (77° F) to 1.75 volts per cell**

1 Hr. Rate	2 Hr. Rate	4 Hr. Rate	8 Hr. Rate	24 Hr. Rate	100 Hr. Rate
79 Ah	100 Ah	103 Ah	113 Ah	129 Ah	146 Ah

*Specifications are subject to change without notice. The data/information contained herein has been reviewed & approved for general release on the basis that this document contains no export controlled information.*



**M8 Threaded Insert Standard Terminals**

All batteries with a "T" at the end of the part number incorporate M8 (copper alloy) threaded insert terminals except PVX-340T (M6) & PVX-420T (M6). All batteries are supplied with silicon bronze bolts, nuts, and washers required for installation.

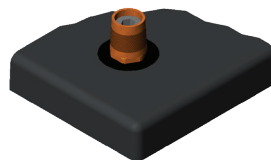

**A SAE Automotive Post**

Optional (copper alloy) terminal installed at the factory. Most batteries are available with an optional factory installed "A" SAE automotive type terminal by adding the appropriate suffix to the end of the part number. For example, order PVX-1040TA instead of PVX-1040T.

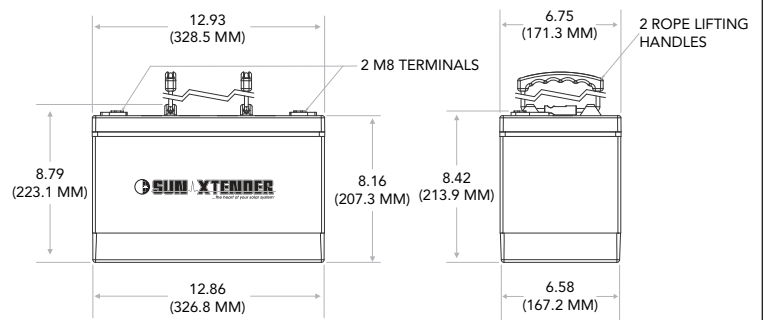

**PVX-1290T**